

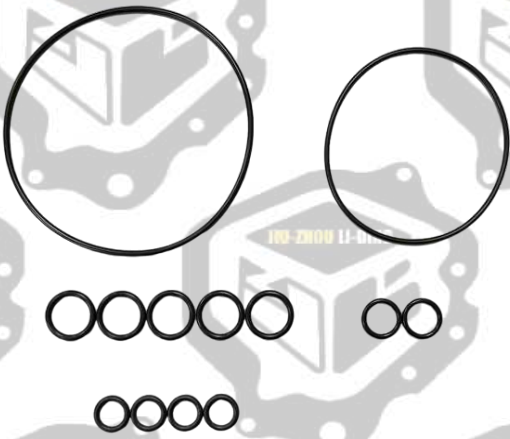





MITSUBISHI

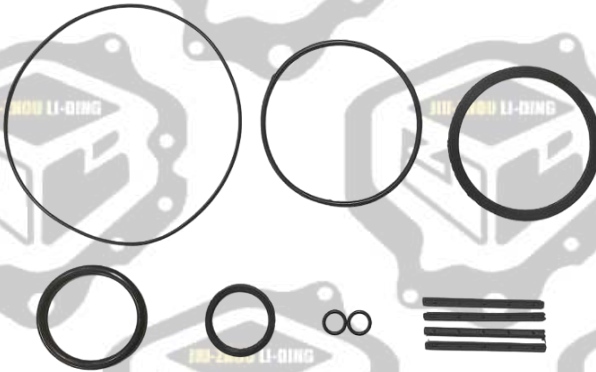

NO.	CAR INFO.	RUBBER KITS
1	4D32/D4AF	
2	4D34	
3	4D56	
4	4DR-5	

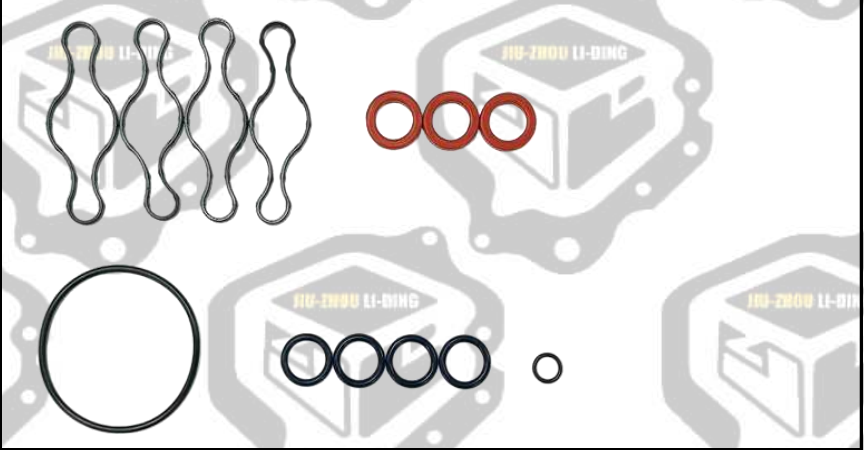
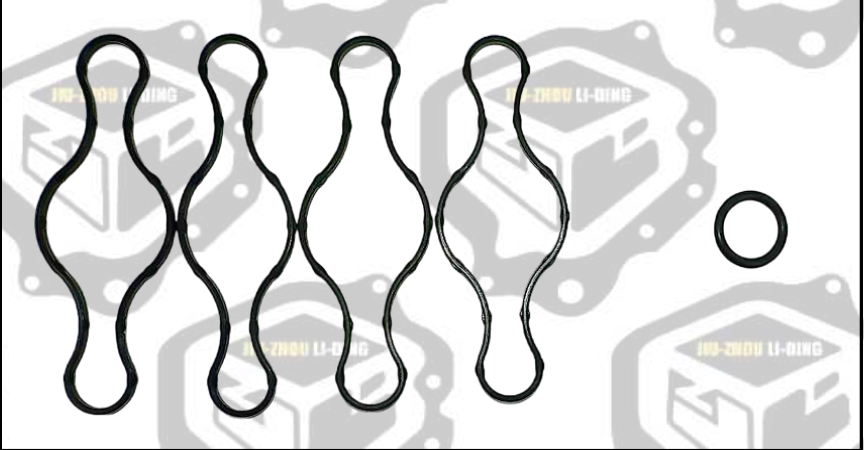
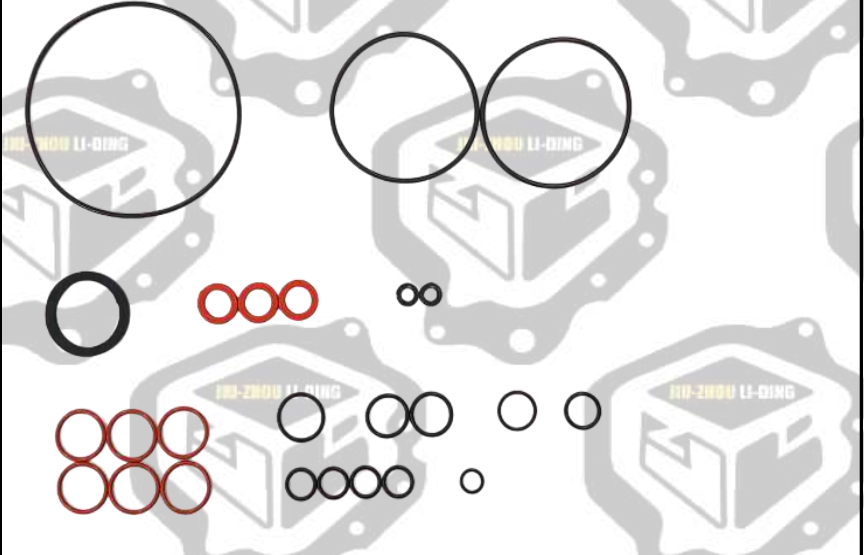
MITSUBISHI

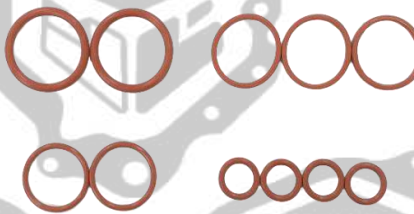
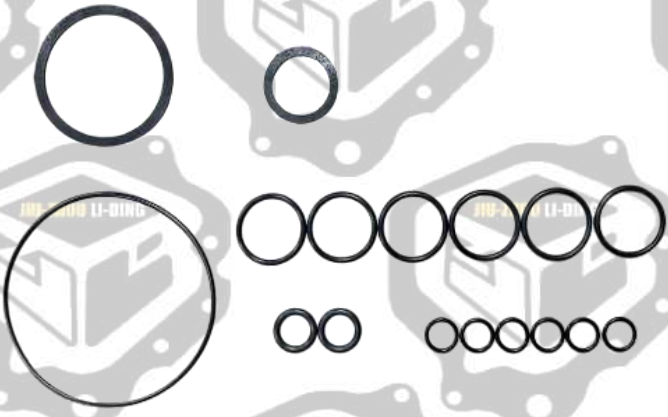
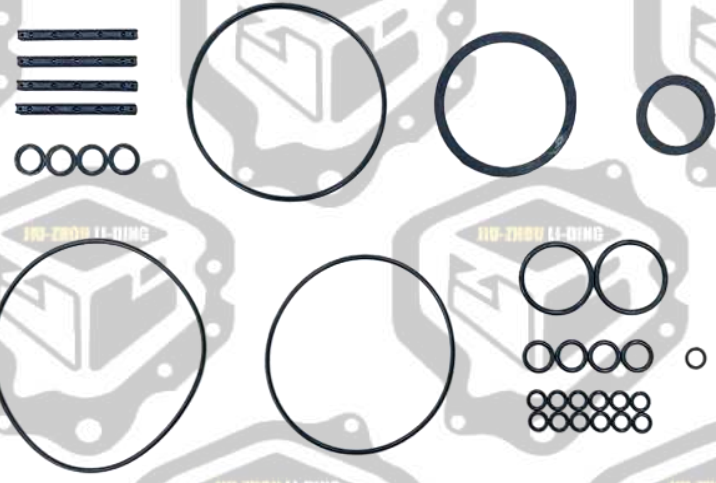
NO.	CAR INFO.	RUBBER KITS
5	4G54	 <p>The rubber kit for the 4G54 engine includes: a large black O-ring at the top; a semi-circular black seal; two black O-rings; a single black O-ring; two black O-rings; and four black O-rings.</p>
6	4M42	 <p>The rubber kit for the 4M42 engine includes: four black wavy seals; three red O-rings; a large black O-ring; and four black O-rings of varying sizes.</p>
7	4M42	 <p>The rubber kit for the 4M42 engine includes: four black wavy seals and one black O-ring.</p>
8	6D14T	 <p>The rubber kit for the 6D14T engine includes: a large black O-ring; two black O-rings; a black O-ring; three red O-rings; two black O-rings; a black O-ring; a 2x2 grid of four red O-rings; a 2x2 grid of four black O-rings; and a single black O-ring.</p>

MITSUBISHI

NO.	CAR INFO.	RUBBER KITS
9	6D22,6D40,6D24T	
10	6DB	
11	6DS7	
12	CE12S	

NO.	CAR INFO.	RUBBER KITS
13	G54B	 <p>The rubber kit for the G54B model includes a large black circular O-ring, a semi-circular black rubber cap, four black O-rings of medium size, one small black O-ring, and a set of eight small black O-rings arranged in two rows of four.</p>
14	G63BT	 <p>The rubber kit for the G63BT model includes a large black circular O-ring, a semi-circular black rubber cap, six black O-rings of medium size, one small black O-ring, and a set of eight small black O-rings arranged in two rows of four.</p>